

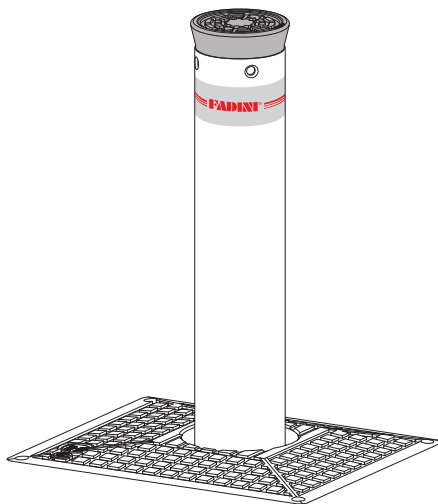

# CORAL

1050 - 1063 - 1080



**FULLY RETRACTABLE OIL-HYDRAULIC BOLLARDS.**  
**POST DIAMETER 100 mm**

**HALL MAGNETIC LIMIT SWITCH**

**GENERAL WARNINGS FOR PEOPLE SAFETY****THANK YOU**

Thank you for purchasing a Fadini product. Please read these instructions carefully before using this appliance. The instructions contain important information which will help you get the best out of the appliance and ensure safe and proper installation, use and maintenance. Keep this manual in a convenient place so that you can always refer to it for the safe and proper use of the appliance.

**INTRODUCTION**

This operator is designed for a specific scope of applications as indicated in this manual, including safety, control and signaling accessories as minimum required with Fadini equipment. □ Any applications not explicitly included in this manual may cause operation problems or damages to properties and people. □ Meccanica Fadini snc is not liable for damages caused by the incorrect use of the equipment, or for applications not included in this manual or for malfunctioning resulting from the use of materials or accessories not recommended by the manufacturer. □ The manufacturer reserves the right to make changes to its products without prior notice. □ All that is not explicitly indicated in this manual is to be considered not allowed.

**BEFORE INSTALLATION**

Before commencing operator installation assess the suitability of the access, its general condition and the structure. □ To check that the ground is stable, to avoid subsequent settling or deformation in the traffic control post installation area. □ Make sure that there is no risk of impact, crushing, shearing, conveying, cutting, entangling and lifting situations, which may prejudice people safety. □ Do not install near any source of heat and avoid contacts with flammable substances. □ Keep all the accessories able to turn on the operator (transmitters, proximity readers, key-switches, etc) out of the reach of the children. □ Transit through the access only with stationary operator. □ Do not allow children and/or people to stand in the proximity of a working operator. □ To ensure safety in the whole movement area of a bollard it is advisable to install photocells, sensitive edges, magnetic loops and detectors. □ Use yellow-black strips or proper signals to identify dangerous spots. □ Before cleaning and maintenance operations, disconnect the appliance from the mains by switching off the master switch. □ If removing the actuator, do not cut the electric wires, but disconnect them from the terminal box by loosening the screws inside the junction box.

**INSTALLATION**

All installation operations must be performed by a qualified technician, in observance of the Machinery Directive 2006/42/CE and safety regulations EN 12453 - EN 12445. □ Verify the presence of a thermal-magnetic circuit breaker 0,03 A - 230 V - 50 Hz upstream the installation. □ Use appropriate objects to test the correct functionality of the safety accessories, such as photocells, sensitive edges, etc. □ Carry out a risk analysis by means of appropriate instruments measuring the crushing and impact force of the main opening and closing edge in compliance with EN 12445.

□ Identify the appropriate solution necessary to eliminate and reduce such risks. □ In case where the gate to automate is equipped with a pedestrian entrance, it is appropriate to prepare the system in such a way to prohibit the operation of the engine when the pedestrian entrance is used. □ Apply safety nameplates with CE marking on the gate warning about the presence of an automated installation. □ The installer must inform and instruct the end user about the proper use of the system by releasing him a technical dossier, including: layout and components of the installation, risk analysis, verification of safety accessories, verification of impact forces and reporting of residual risks.

**INFORMATION FOR END-USERS**

The end-user is required to read carefully and to receive information concerning only the operation of the installation so that he becomes himself responsible for the correct use of it. □ The end-user shall establish a written maintenance contract with the installer/maintenance technician (on -call). □ Any maintenance operation must be done by qualified technicians. □ Keep these instructions carefully.

**WARNINGS FOR THE CORRECT OPERATION OF THE INSTALLATION**

For optimum performance of system over time according to safety regulations, it is necessary to perform proper maintenance and monitoring of the entire installation: the automation, the electronic equipment and the cables connected to these. □ The entire installation must be carried out by qualified technical personnel, filling in the Maintenance Manual indicated in the Safety Regulation Book (to be requested or downloaded from the site [www.fadini.net/supporto/downloads](http://www.fadini.net/supporto/downloads)). □ Operator: maintenance inspection at least every 6 months, while for the electronic equipment and safety systems an inspection at least once every month is required. □ The manufacturer, Meccanica Fadini snc, is not responsible for non-observance of good installation practice and incorrect maintenance of the installation.

**DISPOSAL OF MATERIALS**

Dispose properly of the packaging materials such as cardboard, nylon, polystyrene etc. through specializing companies (after verification of the regulations in force at the place of installation in the field of waste disposal). Disposal of electrical and electronic materials: to remove and dispose through specializing companies, as per Directive 2012/19/UE. Disposal of substances hazardous for the environment is prohibited.

**CE DECLARATION OF CONFORMITY of the manufacturer:**

Meccanica Fadini snc (Via Mantova, 177/A - 37053 Cerea - VR - Italy) declares under own responsibility that: **Coral** complies with the 2006/42/CE Machinery Directive, and also that it is sold to be installed in an "automatic system", along with original accessories and components as indicated by the manufacturing company. An automatic gate operator is, by law, a "machinery" and therefore the installer must fit the equipment with all of the applicable safety norms. The installer is also required to issue the installer's Declaration of Conformity. The manufacturer is not liable for possible incorrect use of the product. The product complies with the following specific norms: analysis of the risks and subsequent action to cure them as per EN 12445 and EN 12453, Low Voltage Directive 2014/35/UE, Electromagnetic Compatibility 2014/30/UE. In order to certify the product, the manufacturer declares under own responsibility the compliance with the EN 13241-1 PRODUCT NORMS.

Meccanica Fadini s.n.c.  
Director in charge

**INSTRUCTIONS TO BE FOLLOWED BEFORE INSTALLING THE OPERATOR**

FOR OPTIMAL APPLICATION AND USE OF THE OPERATOR PLEASE READ THE INSTRUCTIONS AND CONSULT EXPLANATORY DIAGRAMS.

**OVERVIEW**

This product belongs to our range of retractable traffic control posts. It is quick and easy to install, as it does not need to be adjusted or calibrated and has been designed to regulate and prohibit vehicular access.

The oil-hydraulic bollards **CORAL 1050** (500 mm height, with or without LEDs), **CORAL 1063** (600 mm height, with or without LEDs), **CORAL 1080** (800 mm height, with or without LEDs) are fitted with posts made of rust-treated steel, **100 mm** diameter.

The product's hallmark is its ease of installation: once the housing has been secured, the operator can be introduced ready for operation, as soon as the wiring has been completed.

As soon as the retractable post receives a command (from a key switch or radio transmitter), it rises from its interred position.

The post is clearly visible at nighttime thanks to a reflective strip and the possibility of connecting a flashing light or traffic light.

Versions with led lights are also available to signal when the post is in the fully up position and when moving up or down.

Using the electronic microprocessor programmer, the operator can also be customised with presence indicator accessories (magnetic coils, photocells).

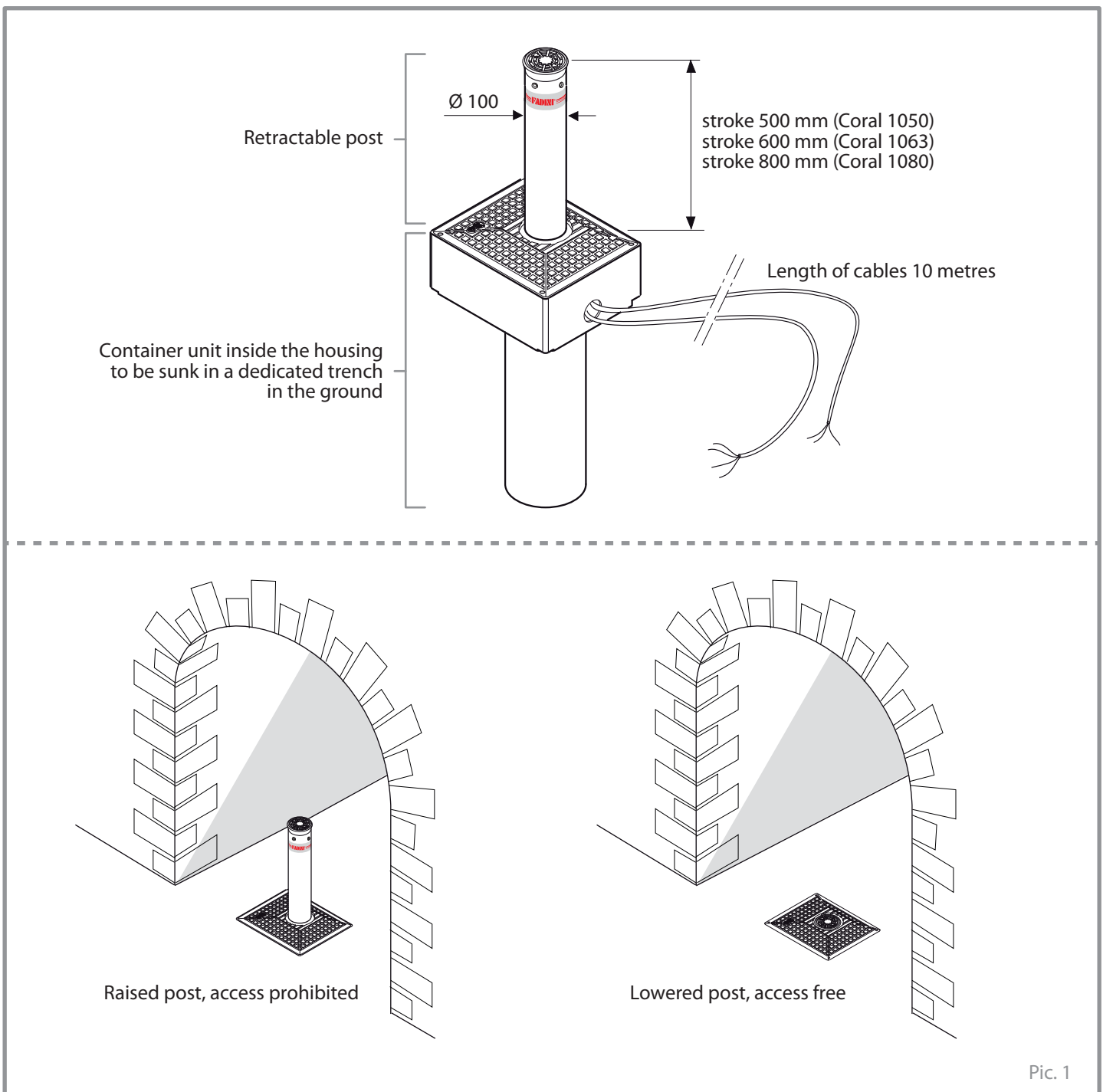

Pic. 1

**PRELIMINARY OPENING OF ALL FUNCTIONAL COMPONENTS**

Start by removing the **cover plate** to reveal the operator and separate the individual components, with the aid of a hoist (Pic. 2): this makes it easy to extract the **internal piston** and hydraulic main unit **container unit**.



**IMPORTANT: TAKE CARE NOT TO TEAR OR CUT WIRES.**

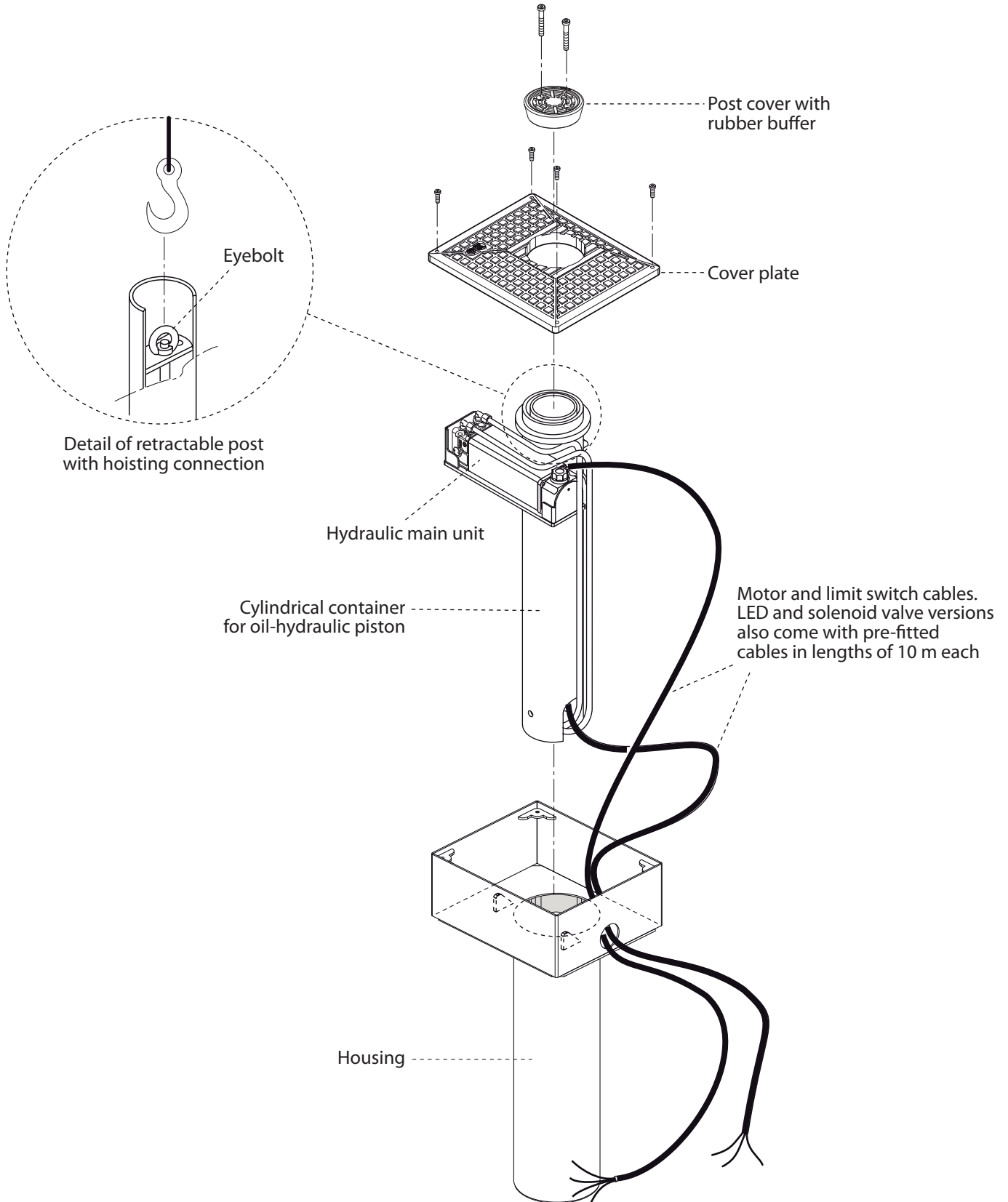

Pic. 2

**ELECTRICAL LAYOUT OF THE INSTALLATION**

To check that the mains supply and voltage to the electric motor is 230 V at 50 Hz.

The power supply to the operator's built-in motor must be made using electricity cables with a 1,5 mm<sup>2</sup> section for a maximum distance of 50 metres. For distances of over 50 metres, use electric cables with sections suited to the installation.

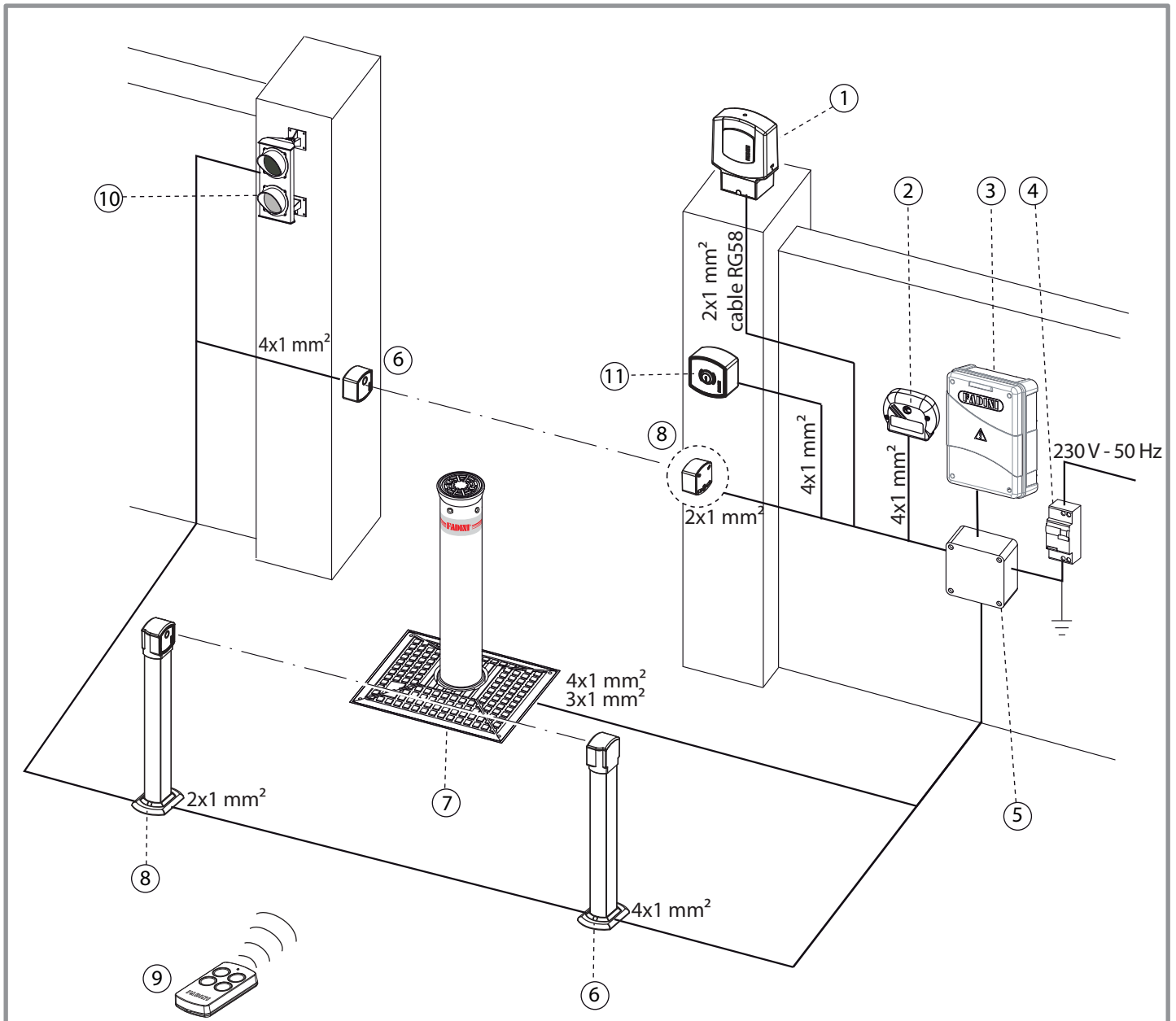

- 1 - Led flashing light with built-in aerial
- 2 - Stand alone radio receiver
- 3 - Electronic programmer
- 4 - Differential circuit breaker (sensitivity 30 mA, protection 6-10 A)
- 5 - Junction box, electric wires
- 6 - Photocell receiver
- 7 - CORAL post
- 8 - Photocell projector
- 9 - Transmitter
- 10 - Traffic light with two lights
- 11 - Key-switch

Pic. 3

ARRANGING THE HOUSING

English

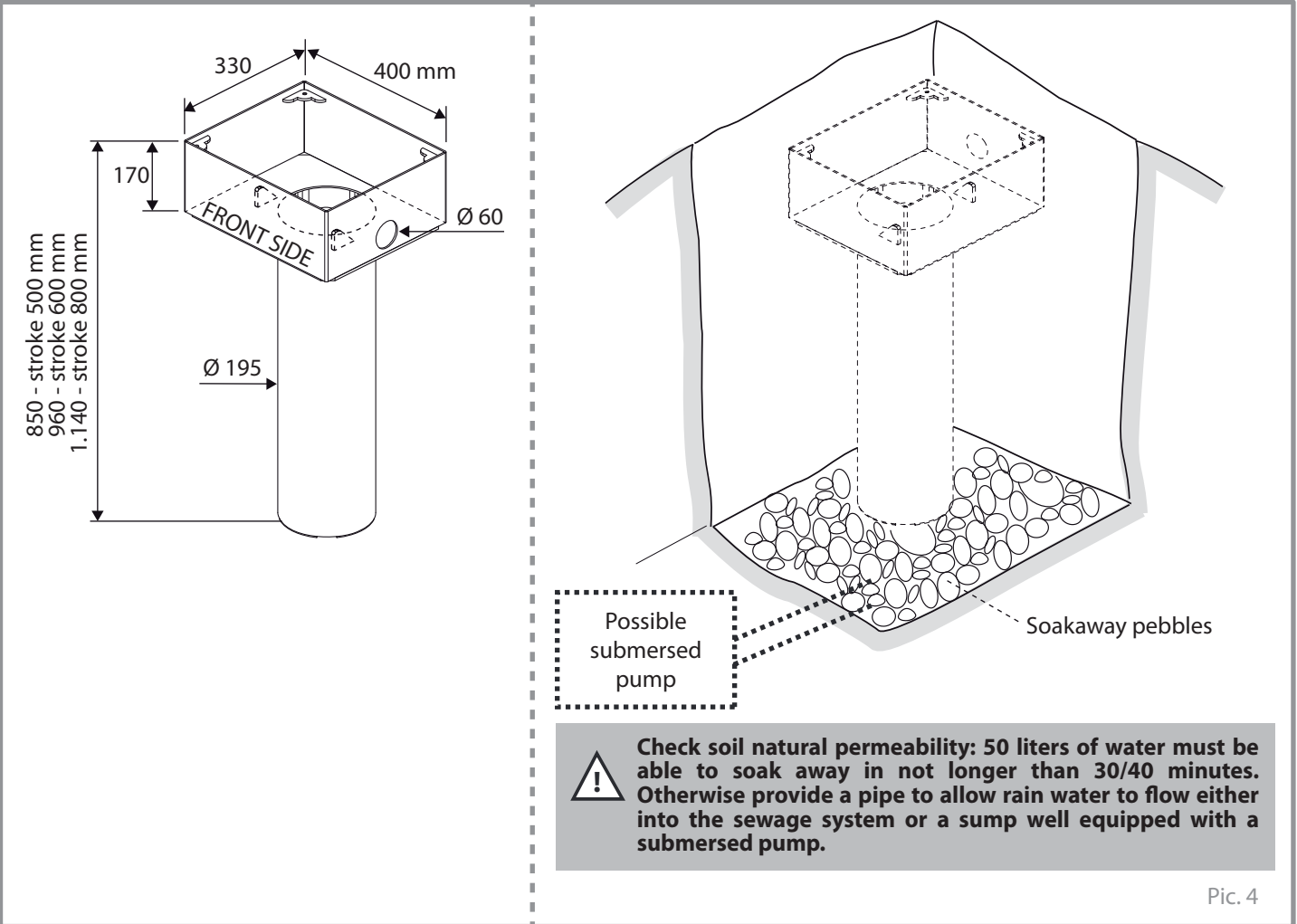

**!** IMPORTANT: once the housing has been positioned and installation completed, it is important for the top edge to be level with the ground.

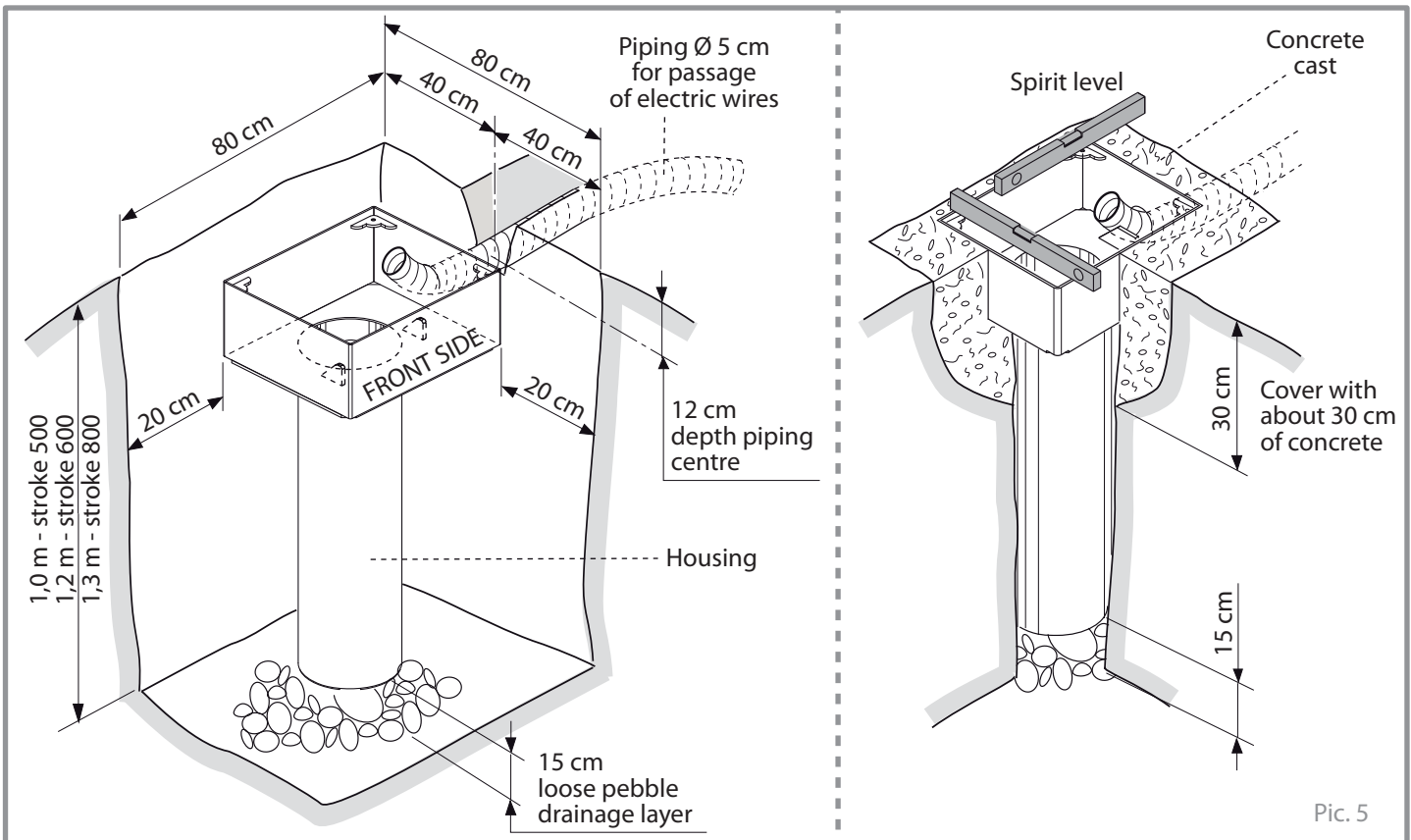

**PLACING THE TRAFFIC CONTROL POST INSIDE THE HOUSING**

Before performing this operation, wait for the housing to be secured firmly in place. Do not commence **until the concrete has set** and the electric wire pipe has been secured and covered with soil.

- Use a hoisting hook to lift the piston unit with the post and main unit (using the eyebolt) and place on top of the housing.
- The subsequent phase of this operation consists in threading the motor, limit switch, solenoid valve and LED power supply electric wires through the piping and simultaneously starting to delicately place the operator inside the housing.

**! IMPORTANT: PASS THE MOTOR, LIMIT SWITCH, SOLENOID VALVE AND LED POWER SUPPLY ELECTRIC WIRES THROUGH THE PIPING WITHOUT TEARING OR CUTTING THE CABLES.**

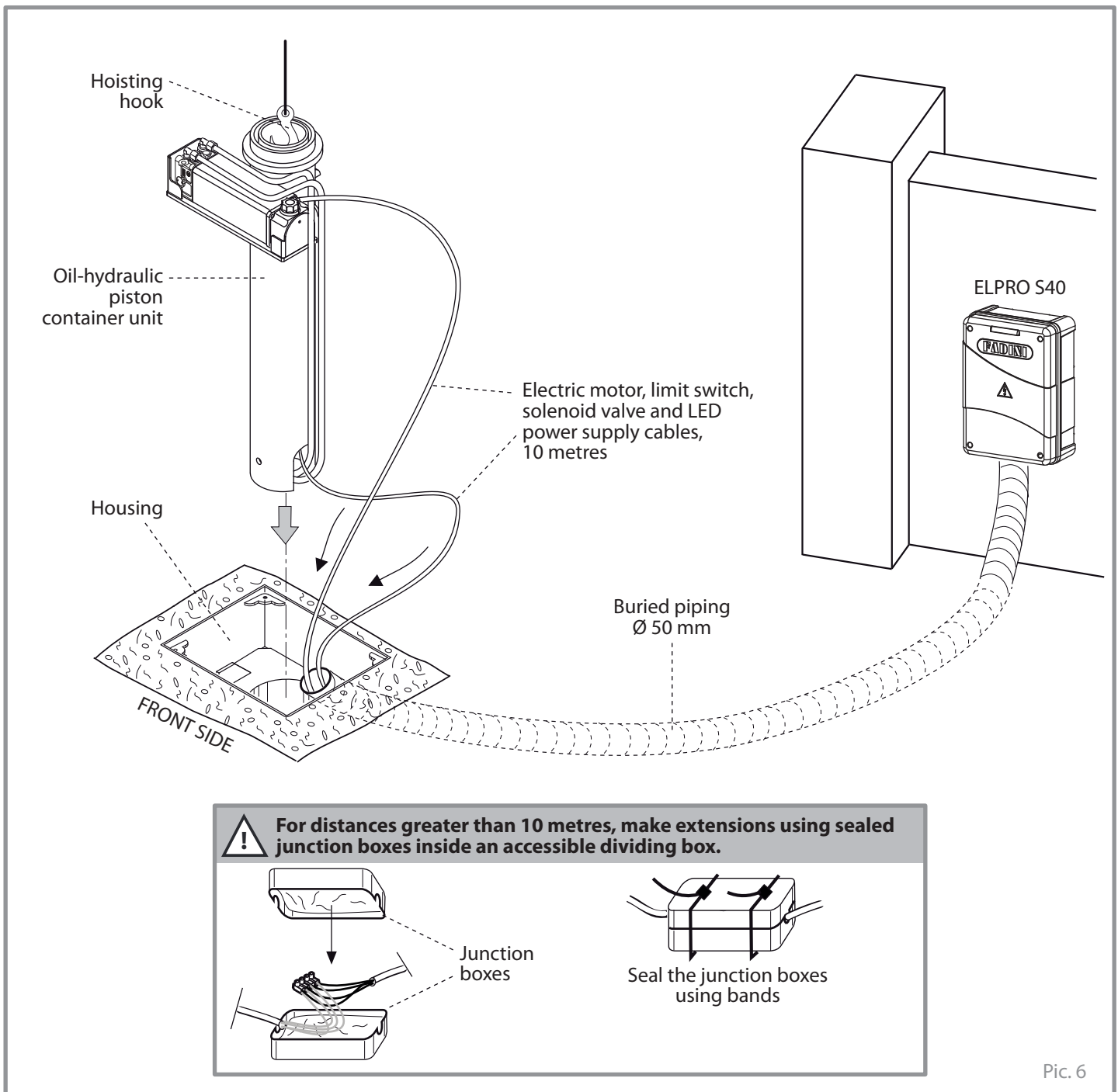
**! IF THE OPERATOR IS REMOVED**

- Disconnect the main switch before opening the lid of the electric cable junction box.
- Do not cut the electric wires, rather remove them from the terminal board loosening the clamping screws inside the dividing box.

MAGNETIC LOOP PREPARATIONS

**IMPORTANT:** make sure that no other electro-magnetic sources are located on or under the ground near the installation to prevent interference or any affecting action with the magnetic loops of the vehicle detecting device if installed or with any other electronic equipment included in the system for commanding and controlling operations.

The magnetic loop detector is a safety device operating all the time to detect any transiting vehicle: the bollard is prevented from rising should a vehicle cross the loop.

A hole is to be dug in the ground as indicated (see relative instructions sheet). For proper and correct functioning of the loop detector it is recommended to strictly keep to the installation geometry as indicated in the instructions.

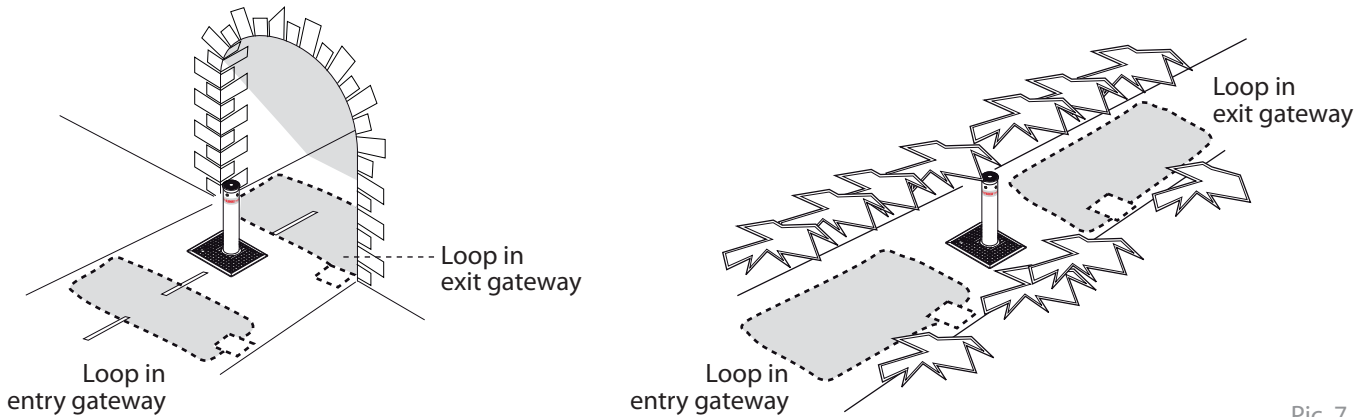

Pic. 7

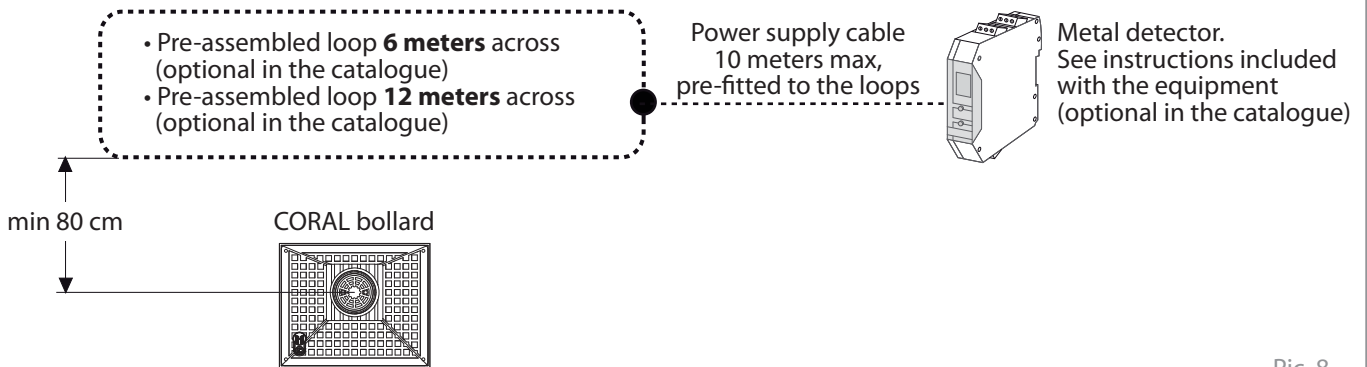

Pic. 8

ARRANGEMENT OF THE PHOTOCELLS

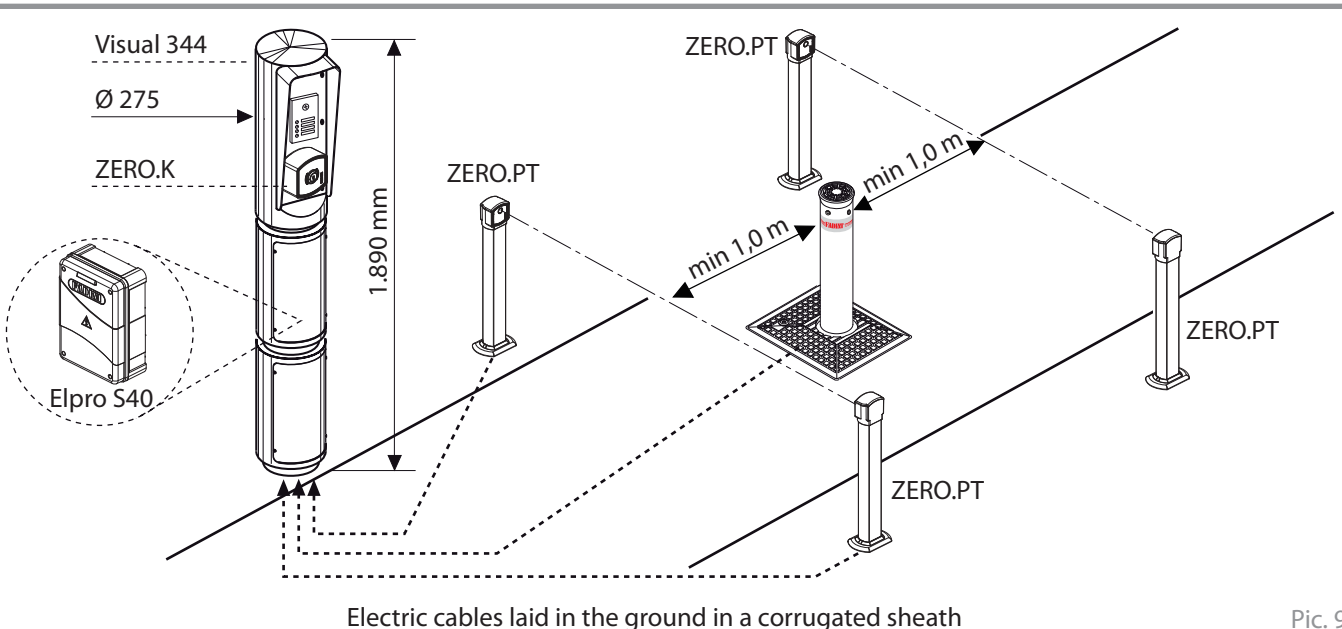

Pic. 9

English



ELECTRICAL CONNECTIONS TO THE CONTROL BOARD

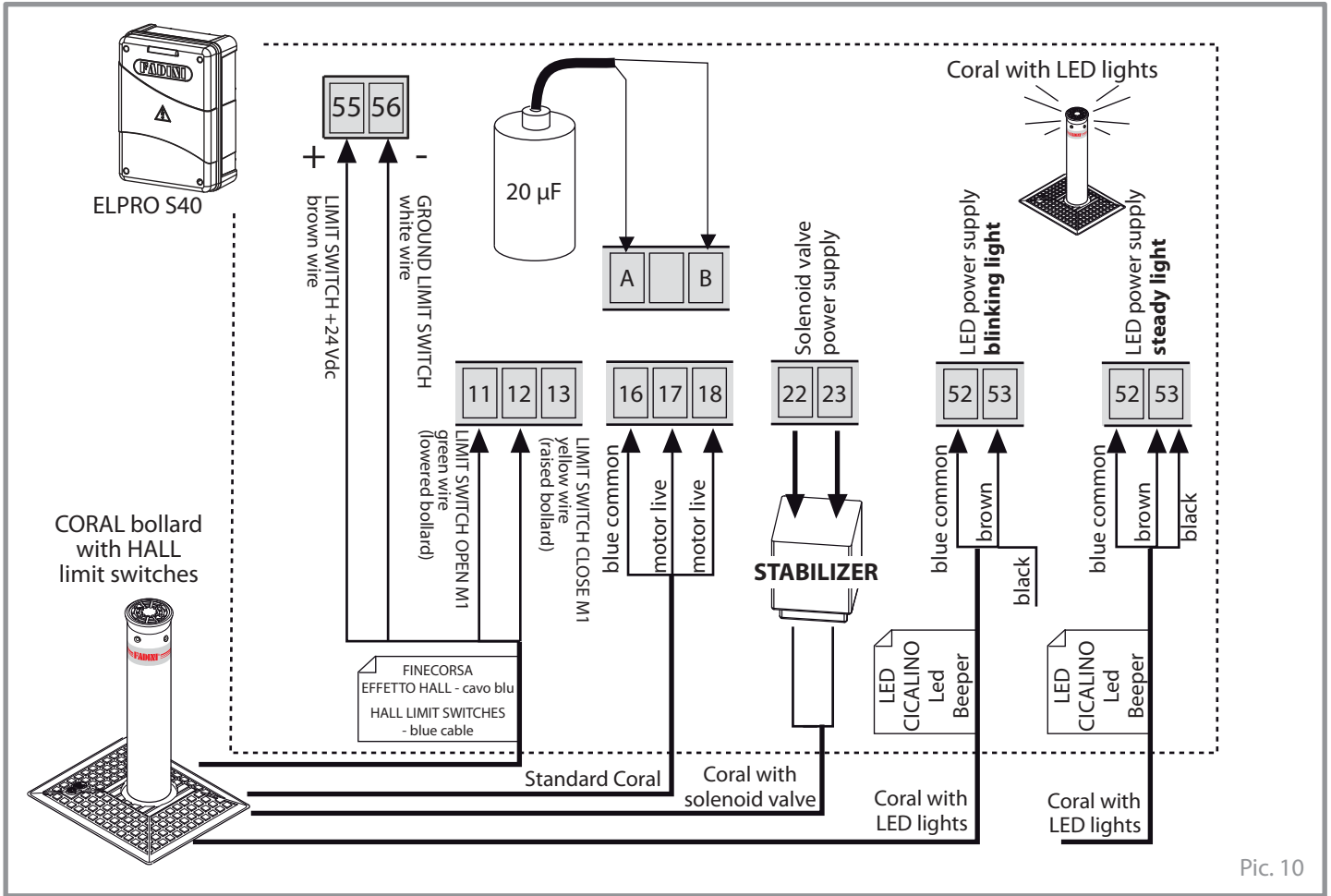

Pic. 10

FIRST OPERATION MANOEUVRES

**NOTE WELL:** supply the system with electric power only after all of the electrical connections have been made as required for proper operations.

Having terminated installation of the traffic control post and all the safety and control accessories (**all of the NC contacts on the Elpro S40 board are to be bridged**), and the respective connections with the Elpro S40 programmer, and having completed thorough risk analysis, the first operation manoeuvres can be performed. If you have a radio transmitter, encode the radio receiver according to the relative instructions before giving the command to raise the retractable post, or give the manoeuvre command using a key switch. Once power is supplied, connect the motor/pump cable and, satisfied that the limit switch LEDs are properly alight, the post should move up on the first commanding pulse; should it fail, disconnect power supply and swap the connections to the live terminals.

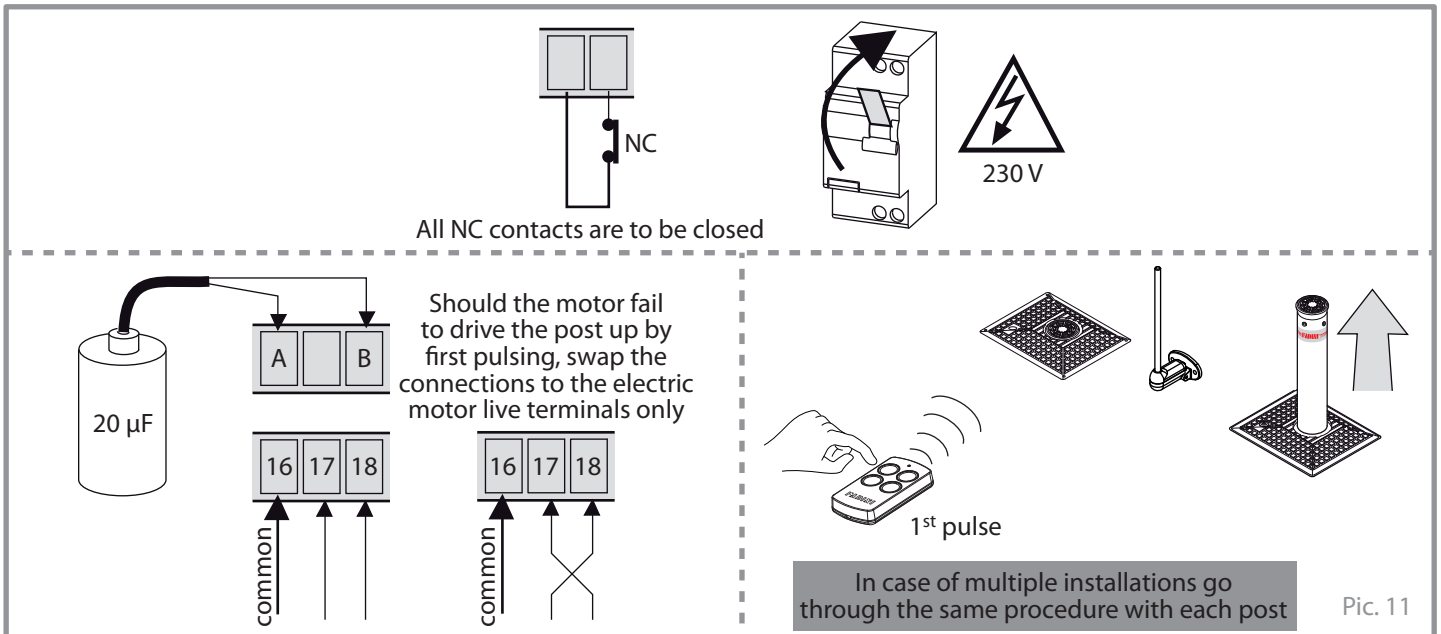

Pic. 11

English

**VERSION OF CORAL WITH SOLENOID VALVE**

In the version of **CORAL with solenoid valve** no manual overriding action is needed, and in case of power failure the post descends automatically flush with pavement level. To enable the solenoid valve to operate properly, the electric wires labelled "ELETTRIVALVOLA - Solenoid valve" from the post assembly are to be connected, through the **voltage stabilizer**, to terminals 22 and 23 in the Elpro S40 control box.

CORAL with solenoid valve

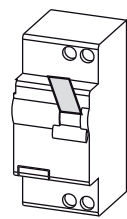
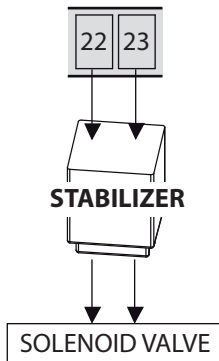

230 V

=

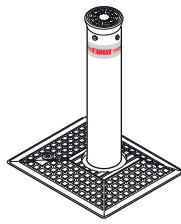

CORAL with solenoid valve

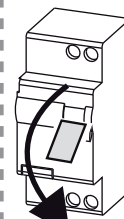

NO

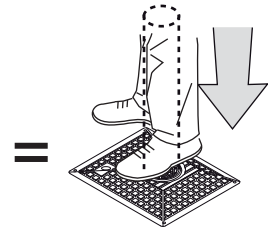

CORAL with solenoid valve



**ATTENTION: IT IS REQUIRED THAT THE POST BE ASSISTED TO REACH THE FULLY FLAT DOWN POSITION**

Pic. 12

**GROUND-LEVEL CLOSURE - COVER PLATE**

- Use the four screws to close the cover plate.
- Lift the retractable post for facilitate closure of the post cover with the buffer, give the command (by encoding a transmitter with the radio receiver or a key switch) to lift the retractable post.

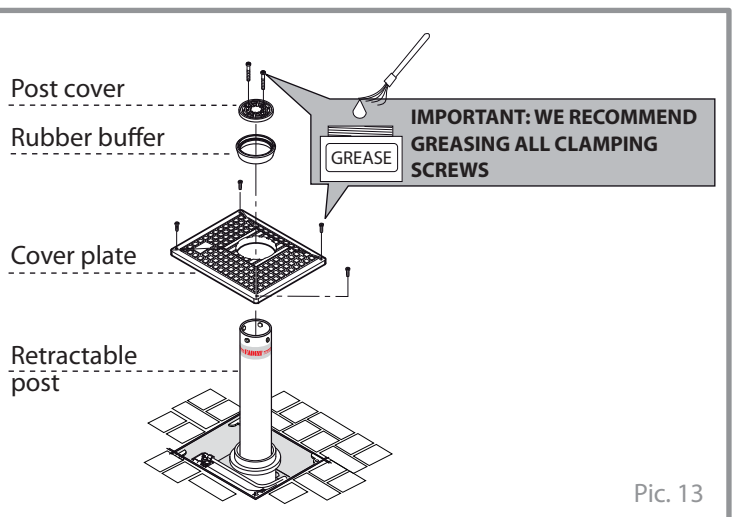

Pic. 13

TECHNICAL DATA

**ELECTRIC MOTOR**

Power output	0,25 kW (0,33 HP)
Supply voltage	230 Vac
Frequency	50 Hz
Absorbed power	400 W
Absorbed current	1,8 ÷ 3,5 A (6 A)
Motor revolutions	2.800 rpm
Capacitor	20 µF
Service mode	S3

**HYDRAULIC ACTUATOR**

Shaft diameter	16 mm
Piston diameter	30 mm
Pre-set pushing power	15 daN
Protection standard complete	IP 55

**OIL-HYDRAULIC MOTOR-PUMP UNIT VICO 2240**

Hydraulic pump	P10
Pump flow rate	4,45 l/min
Working pressure	20 atm
Max pressure	40 atm
Working temperature	-20 °C +80 °C [A]
Oil type	Oil Fadini - Item 708L
Oil reservoir	0,7 liters
Total weight (without oil)	7 kg
Pump protection standards	IP 67

[A]: -40 °C with specific optional accessories (Ref. General Catalogue).

**FEATURES**

	CORAL 1050	CORAL 1063	CORAL 1080
Impact resistance	30.000 J	30.000 J	30.000 J
Crash resistance	150.000 J	150.000 J	150.000 J
Max static load	20.000 kg	20.000 kg	20.000 kg
Bollard weight	86 kg	90 kg	104 kg
Post diameter	ø 100 mm	ø 100 mm	ø 100 mm
Post height	500 mm	600 mm	800 mm
Post finishing	powder coating polyester anthracite grey RAL 7016	powder coating polyester anthracite grey RAL 7016	powder coating polyester anthracite grey RAL 7016
Post material	S235JRH steel	S235JRH steel	S235JRH steel
Bollard thickness	5 mm	5 mm	5 mm
Ground sleeve treatment	hot dip galvanization	hot dip galvanization	hot dip galvanization

**PERFORMANCE - CORAL 1050**

Frequency of use	intensive
Service cycle	rise ~4,7 s dwell 30 s lower ~4,4 s dwell 30 s
Complete cycle time	~69 s
Complete cycles rise-dwell-lower-dwell	No. 52/hour
Annual cycles (with 8 hours of use per day)	No. 151.840

**PERFORMANCE - CORAL 1063**

Frequency of use	intensive
Service cycle	rise ~5,6 s dwell 30 s lower ~5,1 s dwell 30 s
Complete cycle time	~70 s
Complete cycles rise-dwell-lower-dwell	No. 51/hour
Annual cycles (with 8 hours of use per day)	No. 148.920

**PERFORMANCE - CORAL 1080**

Frequency of use	intensive
Service cycle	rise ~7,5 s dwell 30 s lower ~6,6 s dwell 30 s
Complete cycle time	~74 s
Complete cycles rise-dwell-lower-dwell	No. 48/hour
Annual cycles (with 8 hours of use per day)	No. 140.160

OVERALL DIMENSIONS AND DIAGRAM

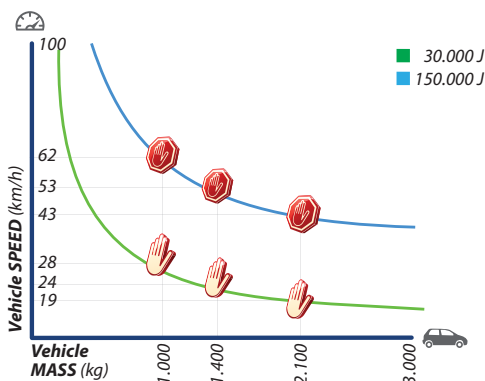

Various factors, such as the compaction index, soil permeability coefficient and kind of concrete may reduce the values indicated in the diagram even significantly.

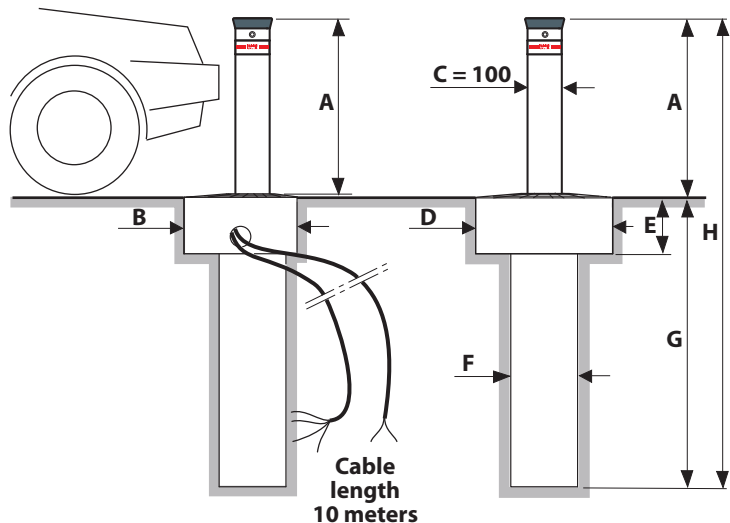

Overall dimensions	A	B	C	D	E	F	G	H
Coral 1050	500	330	ø 100	400	170	ø 195	850	1.350
Coral 1063	600						960	1.560
Coral 1080	800						1.140	1.940

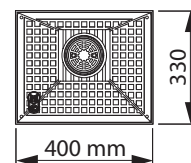

**N.W.** - Measurements are in millimeters (mm).

- Each Coral bollard is supplied equipped with electric cables of 10 meters in length (for electric motor, limit switch, solenoid valve, leds).

Pic. 14

**WARNINGS**

- 1) Installation operations, testing, analysis of the risks and future maintenance are to be executed by qualified and authorized technicians in compliance with the existing regulations ([www.fadini.net/supporto/download](http://www.fadini.net/supporto/download)).
  - 2) This automatic system is intended to be exclusively used for the applications described in this manual, including all of the safety and command accessories, at least as required.
  - 3) Any application not indicated in this manual may cause malfunctioning or damages to people and properties.
  - 4) Make sure the soil is adequate to take the bollard to avoid that settling at a later stage causes problems to the system.
  - 5) Make sure the site is free from utilities that may interfere with it.
  - 6) Make sure that electromagnetic sources are at a suitable distance from the accessories, especially from the loop detectors. The magnetic fields of other sources might affect the detections of the safety loops as well as those of the other command and safety devices of the system.
  - 7) Make sure the power supply to the electric motor is 230 V (50 Hz).
  - 8) **It is recommended either of the following power supply cables:**  
- 10 meters electric cable 4x1 mm<sup>2</sup> for motor pump power supply;  
- 10 meters electric cable 3x0,5 mm<sup>2</sup> for limit switches.
- The section of the ground cable is to be chosen in compliance with the requirements of the installation site.**
- 9) In case any components or accessories need replacing, use only original parts as provided by the manufacturer.
  - 10) The installer shall provide the final user with information related to all of the operating commands and functions of the system, including that concerning lowering of the post in case of an emergency (manual release operation).
  - 11) The installer shall inform the final user of the dangers coming from the presence of persons, especially children, in the proximity of the bollard.
  - 12) The manufacturer reserves the right to change this manual without previous notice.

**As far as configuration and execution of the system are concerned, these are to comply with the laws in the country of installation.**

Meccanica Fadini is not liable for any possible damages derived from incorrect use or from any use not indicated in this manual, furthermore it is not answerable for malfunctioning caused by the use of materials or accessories not approved by the company itself.

It is to be noted that the product respects the impact and breakout resistance values as indicated provided that the installation of the same is carried out in observance of the specifications included in this manual of instructions. Various factors are to be carefully taken into consideration such as compaction index, soil permeability coefficient, concrete type, which may affect the indicated values even significantly.

**PRODUCT SPECIFICATIONS**

Heavy duty, fully retractable, automatic bollard made up of an incorporated oil-hydraulic motor pump unit and an oil-hydraulic actuator inside the moving cylinder. Suitable for applications in private and commercial areas, and for industrial installations. IP67. The height of the rising cylinder (from ground level) can be 500/600/800 mm. The rising cylinder is made of S235JRH steel, thickness 5 mm and Ø 100 mm, cathodolysis treated and powder coated. Rubber ring on cylinder head. Cathodolysis treated aluminium cover with slip proof finish on treadable top. Rising cylinder fitted with high intensity, microprismatic, retroreflecting approved sticker (h 80 mm), available with signal LEDs (N.4) with flashing light fitted all around the top. Hot dip galvanized steel casing for ground foundation, fitted with a cover allowing access to the hydraulic release for manual lowering of the bollard by a special spanner in an emergency. Impact resistance 30.000 J, breakout resistance 150.000 J, static load max 1.600 kg in standing position, max 20.000 kg in lowered position. Working temperature -40 °C +80 °C. Supply voltage 230 Vac ± 10%, 50 Hz. Absorbed power 330 W. Rising time ~ 4,7 s [rising cylinder H 500 mm], ~ 5,6 s [rising cylinder H 600 mm] ~ 7,5 s [rising cylinder H 800 mm]. Frequency of use 2.000 cycles/day. Hydraulic device to lock the bollard in the standing position, on request a solenoid valve can be fitted for the spontaneous descent of the bollard in case of a power failure.





## MAINTENANCE RECORD

hand over to the end user of the installation



Installation address:		Maintainer:	Date:	
Installation type:		Operator model:	Quantity of models installed:	
Sliding gate	<input type="checkbox"/>	Folding door	<input type="checkbox"/>	Dimensions per gate leaf:
Swinging gate	<input type="checkbox"/>	Road barrier	<input type="checkbox"/>	
Over-head door	<input type="checkbox"/>	Bollard	<input checked="" type="checkbox"/>	Installation date:
Lateral folding door	<input type="checkbox"/>	.....	<input type="checkbox"/>	
<p><b>NOTE WELL:</b> this document must record any ordinary and extraordinary services including installation, maintenance, repairs and replacements to be made only by using Fadini original spare parts. This document, for the data included in it, must be made available to authorized inspectors/officers, and a copy of it must be handed over the end user/s.</p> <p>The installer/maintainer are liable for the functionalities and safety features of the installation only if maintenance is carried on by qualified technical people appointed by themselves and agreed upon with the end user/s.</p>				
N°	Service date	Service description	Technical maintainer	End user/s
1				
2				
3				
4				
5				
6				
<hr/> Stamp and signature installation technician/maintainer		<hr/> Signed for acceptance end user buyer		

give to the end-user of the installation

English



**GUIDANCE FOR PROPER USE** (for the end user)**MAINTENANCE****OPERATIONS FOR ORDINARY ROUTINE MAINTENANCE OF FADINI AUTOMATIC BOLLARDS (EVERY SIX MONTHS)**

The standard maintenance routine sequence is as follows:

- Clean the ground cylinder and suck all material settlements.
- Clean water drains located at the bottom of the ground cylinder and/or excavation pit.
- Check any possible oil leaking from the hydraulic piston and, in case, fix it.
- Overhaul the screws fastening the bollard to the ground cylinder, making sure they are properly tightened and lubricated.
- Check the oil-hydraulic motor-pump and oil pressure by assessing the rising times of the bollard. If required, top up oil in the reservoir and/or parallel add an extra capacitor to the existing one (instructions manual is to be referred to).
- Check the correct functioning of the signal LED lights (if incorporated) in the bollard head.
- Sight check the electronic board controlling the bollard/s (e.g.: "flooded" relay contacts, oxidized terminal clamps, etc.).
- Check the correct functioning and positioning of the limit switches.
- Check the release system for bollard manual operations.
- Clean and recondition the rising cylinder if required, e.g.: paint patching up, replacing the back reflecting sticker and /or the cover fitted with rubber edge.

**IF OPTIONAL ACCESSORIES ARE INCLUDED, FURTHER MAINTENANCE IS REQUIRED AS FOLLOWS:**

- Check the correct functioning of the safety accessories such as the inductive loop/s and the photocells.
- Check the correct functioning of the radio receiver and all of the remote controls.
- Check the correct functioning of the pressure switch.
- Check the correct functioning of the beeper.
- Check the correct functioning of the traffic lights and the respective control card.
- Check the correct functioning of the solenoid valve in emergency cases such as power failure or disconnection, assess therefore the status of the 24 Vdc voltage stabilizer.
- Check the correct functioning of E.A.R. 35 acoustic analyzer to lower the bollard in emergency.

**MANUAL RELEASE OPERATIONS**

In the case of a blackout, the post can be lowered manually following the instructions show in pic. 15.

